

UNITEC CON SPAN 400

Excelente rendimiento para operaciones de mantenimiento cerca de líneas eléctricas, o en entornos con alta agresividad química y oxidativa y zonas, en riesgo.

Diseñado para cumplir con las regulaciones de trabajo en altura.

Adecuado para aplicaciones eléctricas

CERTIFICADO:
DIN EN 1004:2005-05
ANSI A 10.8
CAN/CSA-S269.2-M87

SERIES:
29"/0,73m Estrecho
54"/1,37m Doble Ancho
6'-8'-10'/2,00-2,50-3,00 Longitud

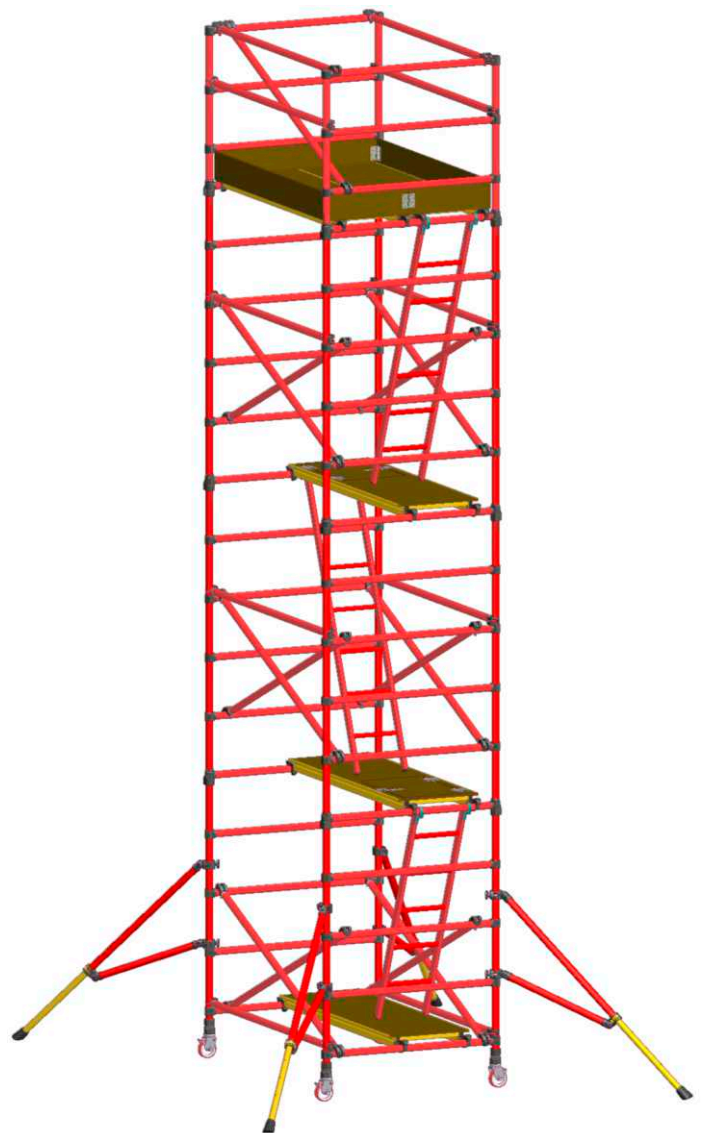

COMPONENTES



Placa de base
cod. BP00

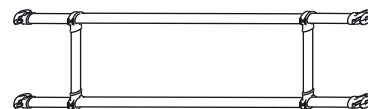
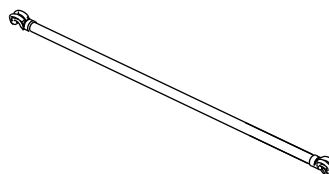
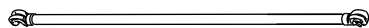

Tamanos:
cod. 93633 Ø 127mm
cod. 62152 Ø 203mm

Longitudes tirante horizontal:
2,00m cod. UHB06
2,50m cod. UHB08
3,05m cod. UHB10

Longitudes tirante diagonal:
2,00m cod. UDB06
2,50m cod. UDB08
3,05m cod. UDB10

Longitudes tirante barandilla:
2,00m cod. U24342 06
2,50m cod. U23996 08
3,05m cod. U14997 10

Bastidores base estrechos

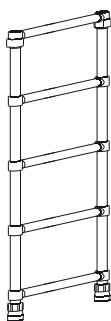
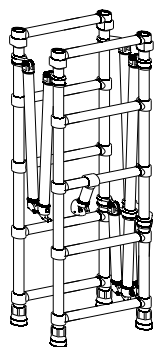

cod. UQB2906A
cod. UQB2908A

cod. USB2900A

Bastidores de estension estrechos

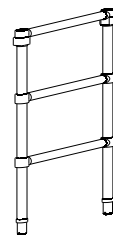
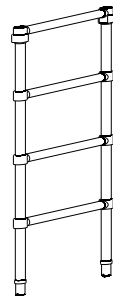
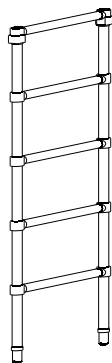

cod. UEX2969A

cod. UEX2956A

cod. UEX2940A

Bastidor de protección extremo

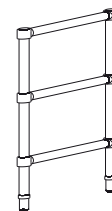

cod. UGR2937

Bastidores base anchos

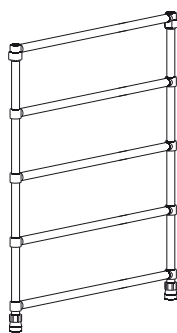
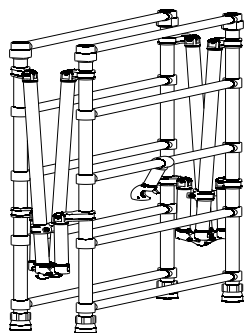

cod. UQB5406A
cod. UQB5408A

cod. USB5400A

Bastidores de estension anchos

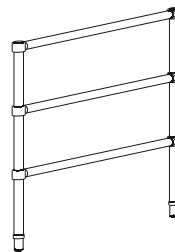
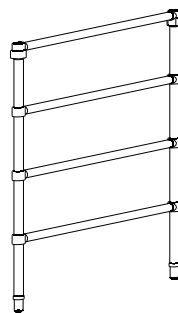
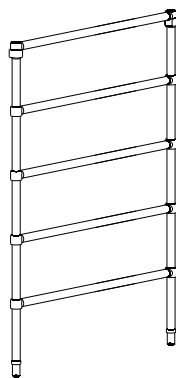

cod. UEX5469A

cod. UEX5456A

cod. UEX5440A

Bastidor de protección ancho

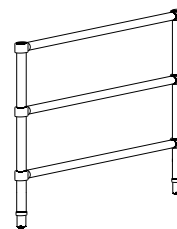

cod. UEX5437

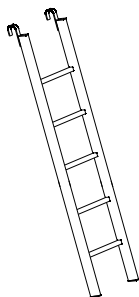

Escalera media inclinada
cod. UST56

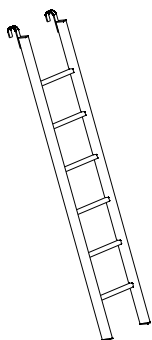

Escalera larga inclinada
cod. UST69

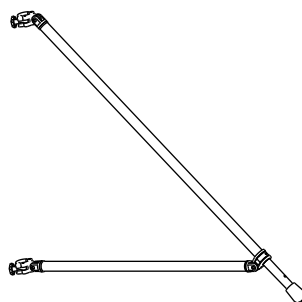

Estabilizador largo
cod. PSX66 GRP

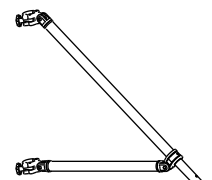

Estabilizador medio
cod. PSR42 GRP

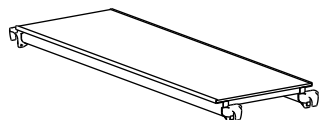

Longitudes
plataforma standard:
2,00m - cod. USP06-61
2,50m - cod. USP08-61
2,00m - cod. ASP06-61
2,50m - cod. ASP08-61
3,05m - cod. ASP10-61

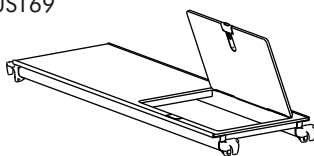

Longitudes
plataforma con trampilla:
2,00m - cod. UHP06
2,50m - cod. UHP08
2,00m - cod. AHP06
2,50m - cod. AHP08
3,05m - cod. AHP10

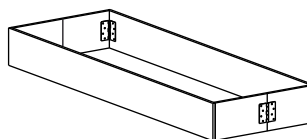

Longitudes calapiés estrecho:
2,00m cod. WTB2906
2,50m cod. WTB2908
2,00m cod. ATB2906
2,50m cod. ATB2908
3,05m cod. ATB2910

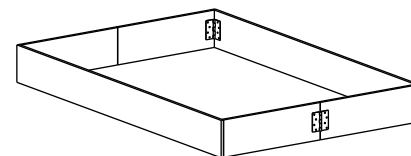

Longitudes calapiés ancho:
2,00m cod. WTB5406
2,50m cod. WTB5408
2,00m cod. ATB5406
2,50m cod. ATB5408
3,05m cod. ATB5410